

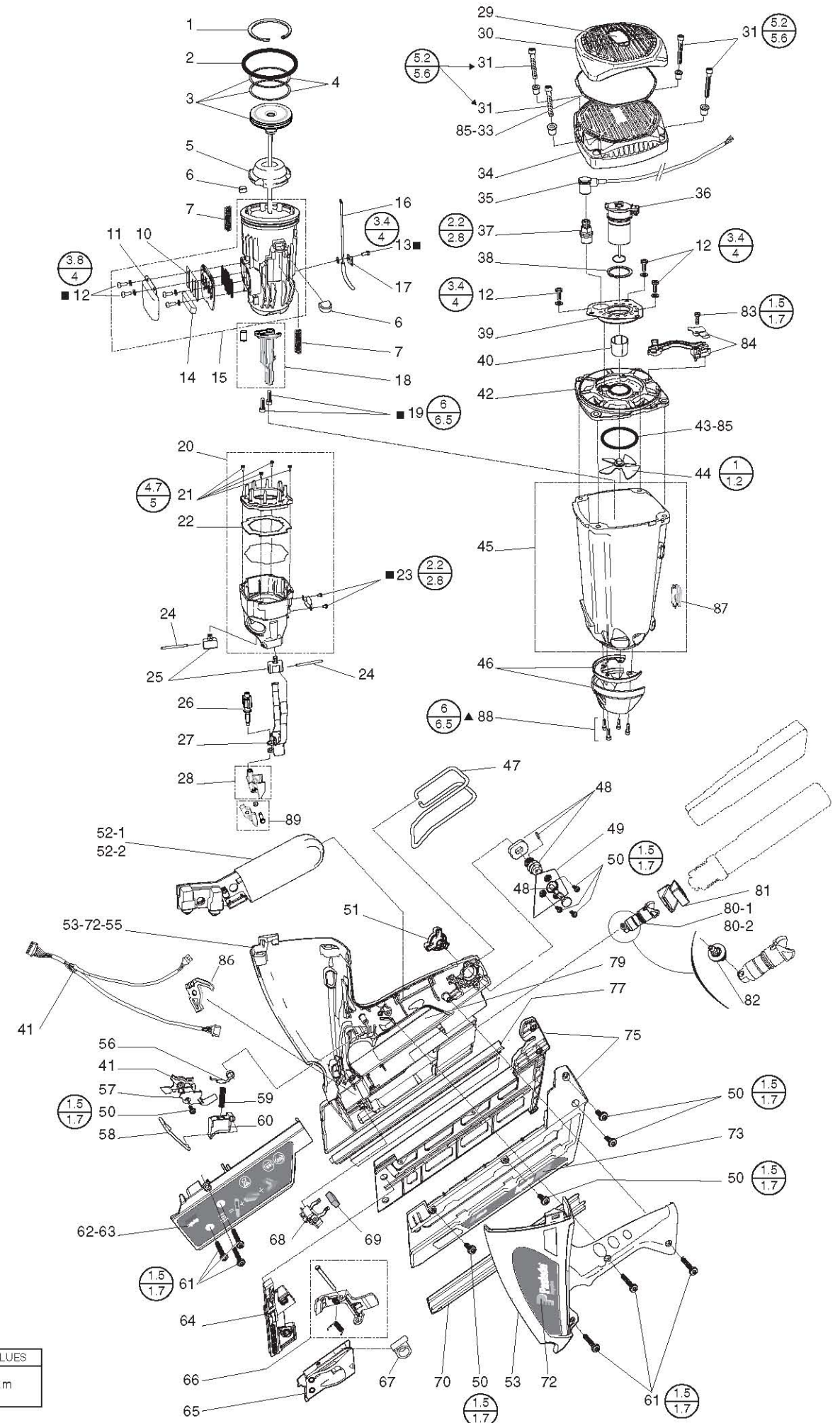







1	336680	1	Retainer ring	57	013785	1	Contact plate
2	013743	1	Cylinder o-ring	58	013784	1	Combustion chamber lock bar
3	014386	1	Piston assembly	59	013783	1	Trigger spring
4	336670	2	Piston ring	60	013782	1	Trigger
5	013778	1	Bumper	61	013799	6	Screw Eco-syn Torx 4x25
6	013758	2	Rubber stop	62	014395	1	Handle cover assembly
7	013779	2	Combustion chamber spring	63	014396	1	Under magazine label
10	336560	1	Reed valve	64	014397	1	Shear block
11	336580	1	Muffler cover	65	014398	1	Follower assembly
■ 12	405141	5	Screw swage form 4-11	66	014399	1	Follower button assembly
■ 13	405140	1	Screw swage form 4-9	67	013767	1	Follower spring
14	336570	1	Muffler	68	013746	1	Battery electrical connection ass.
15	013751	1	Cylinder assembly	69	401450	1	Battery pad
16	013737	1	Injection pipe assembly	70	013764	1	Cover plate magazine (short)
17	013738	1	Bracket fuel line	72	013772	1	Assembly carter labels
18	014387	1	Nose	73	014401	1	Magazine label (short)
■ 19	013796	2	Screw CHC M5-16	75	014402	1	Magazine assembly (short)
20	013749	1	Combustion Chamber Assembly	77	014403	1	Nail channel (short)
21	900456	4	Screw swage form 4-15	79	014404	1	Nameplate label
22	013750	1	Seal	81	013786	1	Ejection button assembly
23	013805	2	Screw taptite 4x8	82	013739	1	Electrovalve plug connection
24	013781	2	Combustion chamber stop pin	83	404702	1	Screw thread forming 6 x 3/8
25	013780	2	Combustion chamber stop assembly	84	013808	1	Wires guide
26	014388	1	Knob assembly	85	013231	1	Maintenance kit (filter + o'ring)
27	013744	1	Upper probe assembly	86	013811	1	Wire assembly guide
28	014389	1	Probe	87	013812	1	Electrovalve heat protection
29	013791	1	Grill label	▲ 88	013813	4	Screw CHC M5-16
30	013790	1	Grill assembly	89	014099	1	Probe pin PPN35i
31	013797	4	Screw CHC M5-35				
33	013748	1	Filter				
34	013770	1	Cap				
35	013732	1	Spark plug contact assembly				
36	013287	1	Motor assembly				
37	013731	1	Spark plug assembly (901706)				
38	321610	1	Retaining ring				
39	334310	1	Motor mount				
40	321590	1	Motor sleeve				
41	013289	1	Wire assembly				
42	013740	1	Cylinder head				
43	012012	1	Cylinder head O-Ring				
44	321660	1	Fan blade assembly				
45	014392	1	Carter				
46	013787	1	Nose protection				
47	013789	1	Belt hook				
48	013792	1	Magazine ball assembly				
49	013788	1	Cover ball				
50	013798	8	Screw Eco-syn Torx 4x12	52-1	013299		Red MEFI IM90i
51	013793	1	Magazine knob	80-1	013298		Red electrovalve assembly
53	014393	1	Handle assembly				
55	014394	1	Handle label	52-2	013730		Black MEFI IM90i
56	013734	1	Contact level	80-2	013771		Black electrovalve assembly

■ Apply Loctite RC-620 (Green)  
 ▲ Apply Loctite 243 (Blue)  
 → Denotes Change

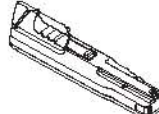

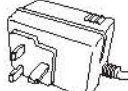
TORQUE VALUES	
MIN	N.m
MAX	

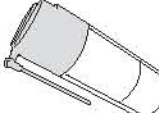
## ACCESSORIES

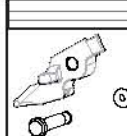
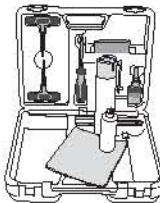
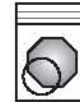
<b>Car Adapter</b> Enables you to re-charge your battery with your vehicle's electrical system.		Part No. 900507
<b>Battery Cell</b>		Part No. 013227
<b>Battery Charger</b>		Part No. 013229
<b>Transformer</b>		Part No. 210660 (UK)
<b>4 mm Hex Key</b>		Part No. 013066
<b>Orange Safety Glasses</b>		Part No. 011117
<b>Paslode Intensive Tool Cleaner 300 ml</b>		Part No. 115251
<b>Paslode Impulse Lubricating Oil</b>		Part No. 401482
<b>Probe kit</b>		Part No. 014099
<b>Cleaning Kit</b> Contains all the necessary to clean any Impulse tool		Part No. 013060
<b>Maintenance Kit</b> (Filter + o'ring)		Part No. 013231

  
 An Illinois Tool Works Company  
 Route de Lyon - BP 104  
 F - 26501 Bourg Les Valence - Cedex France



014091(UK)



**PPN35i**

**IMPORTANT!  
DO NOT DESTROY**

Always refer to operating and safety instructions (#014084 & #014083) for detailed information on this tool. It is the customer's responsibility to have all operators and service personnel read and understand this information.

TOOL SCHEMATIC AND PARTS